

A4021 Series VALVE PROVING SYSTEM

INSTRUCTION SHEET



APPLICATION

The A4021 is a self-checking microprocessor based Valve Proving System (VPS). The A4021 checks the effective closure of automatic shut-off valves by measuring the pressure differential between two valves during the test sequence. Subbase and pressure switch are required to complete the system.

When during the test sequence of the A4021 a failing valve is detected, the A4021 will go into a non-volatile lock-out status, generates an alarm and prevents a burner start-up.

The intended application is for gas fired power burners and other large capacity gas firing installations, where according to the European norm EN676 a valve proving system can be used as an alternative for pre-purging the combustion chamber. And for all combustion applications with or without pre-purge with a capacity of more than 1200 kW a valve proving system is mandatory.

CONTENTS

Application	1
Description	2
Working principle	2
Specifications	5
Mechanical	5
Electrical	5
Functional	5
Dimensional drawings	7
Installation and wiring	8
Installation	8
Mounting wiring subbase	8
Wiring	8
General considerations	8
Wiring	8
Pressure switch	8
General wiring diagrams	8
Operation	10
Checkout	11
Final checkout of the installation	11
Troubleshooting	12

DESCRIPTION

The A4021 valve proving system checks the effective closure of the valves *before* burner start-up (pre-configuration) or *at the end of a heat demand* (post-configuration). The configuration can be set by means of wiring the A4021 in two different ways, see Fig. 1. and 2.

The flow chart (Fig. 4.) and sequence diagram (Fig. 5.) explain the procedure during the valve proving.

An external pressure switch monitors the pressure between both valves. The pressure switch must be set to half the inlet pressure in order to test both valves with the same sensitivity. After a short interruption of the mains supply during valve proving or during RUN, the A4021 restarts automatically. The A4021 valve proving system can be used with several pilot-valve configurations, like intermittent and interrupted pilot systems and 3-valve configurations as well.

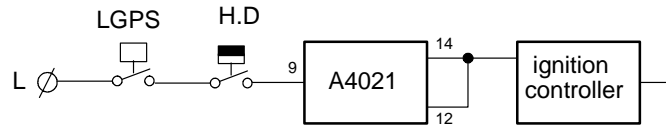

Fig. 1. Valve proving *pre-configuration*.

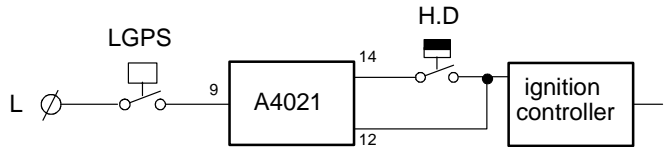

Fig. 2. Valve proving *post-configuration*.

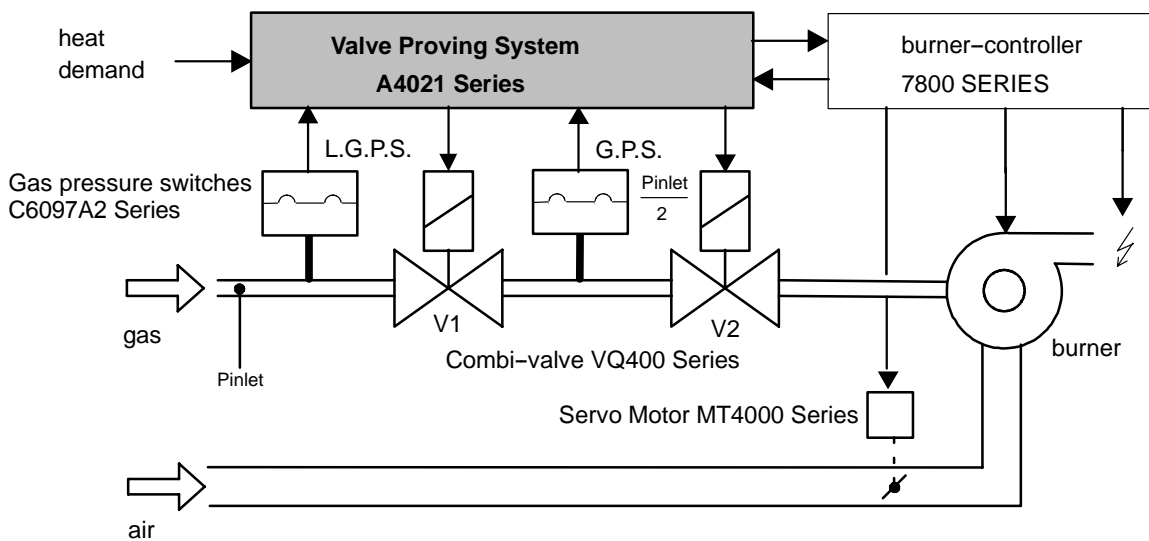

Fig. 3. System set-up .

Working principle

The A4021 valve proving system is based on the pressure status-principle. This means that the valves are checked by means of measuring (on/off) the pressure in the gas-pipe between the two safety-valves. This system will only work when there is sufficient gas-pressure (line-pressure). Therefore a Low Gas Pressure Switch (LGPS) is part of the installation. When the line-pressure (Pinlet) is too low the LGPS will disable the valve proving system.

The section between the two valves is filled with gas (high-pressure status) by opening valve-1 (upstream valve) and the pipe is emptied (low-pressure status) by closing valve-1 and opening valve-2 (down-stream). When one of the valves is leaking this will mean that either the pressure will not maintain the high-pressure status or the low-pressure status at the end of the test period.

For this method of testing, the test time is a function of three parameters.

- inlet pressure
- volume between the valves.
- maximum burner capacity.

The test time can be calculated as given in the Product Handbook.

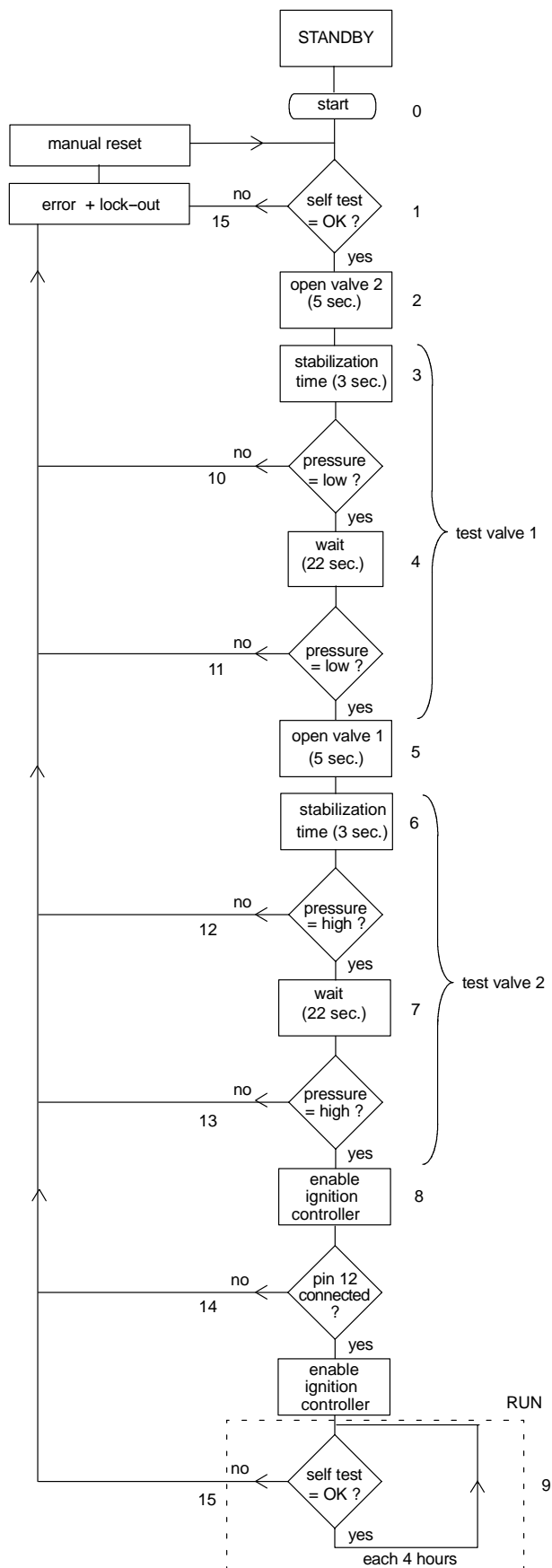

Fig. 4. General flow chart valve proving (given timings for A4021A1002/1010)

Table 1. Sequence timings for normal operation

State	Description	Time ¹⁾ (s)
0	STANDBY	infinite ²⁾
1	self-test + memory test	< 2
2	V2 powered	5
3	waiting for pressure to get low	3
4	wait	22
5	valve 1 powered	5
6	waiting for pressure to get high	3
7	wait	22
8	waiting for ignition controller to start	indefinite ³⁾
9	RUN period, every 4 hours self-test	
10	alarm, "error valve 1"	indefinite
11	alarm, "valve 1 failing/leaking" ⁵⁾	indefinite
12	alarm, "error valve 2"	indefinite
13	alarm, "valve 2 failing/leaking" ⁵⁾	indefinite
14	alarm, "error heat demand"	indefinite
15	alarm, "self-test error" ⁴⁾	indefinite

- 1) Timings depending on O.S. numbers, shown A4021A1002/1010.
- 2) STANDBY can be infinite time period
- 3) Depending on pre-purge and start-up time of the used ignition controller.
- 4) When during the test sequence a fault is discovered by the A4021, the system will go into a non-volatile lock-out and generate an alarm "self test error" (see also Troubleshooting section). The "self test error" also occurs when the anti-recycle-counter reaches the value 10, see also page 10 of the Product Handbook.
- 5) Leakage $\geq 0.1\%$ of maximum flow-rate.

! WARNING

No standard valve proving after lock-out of the ignition controller. Valve proving after lockout maybe required, this can be achieved by special wiring diagrams. E.g. when a DTSP switch is used to reset the ignition controller and interrupting the heat-demand for the A4021A.

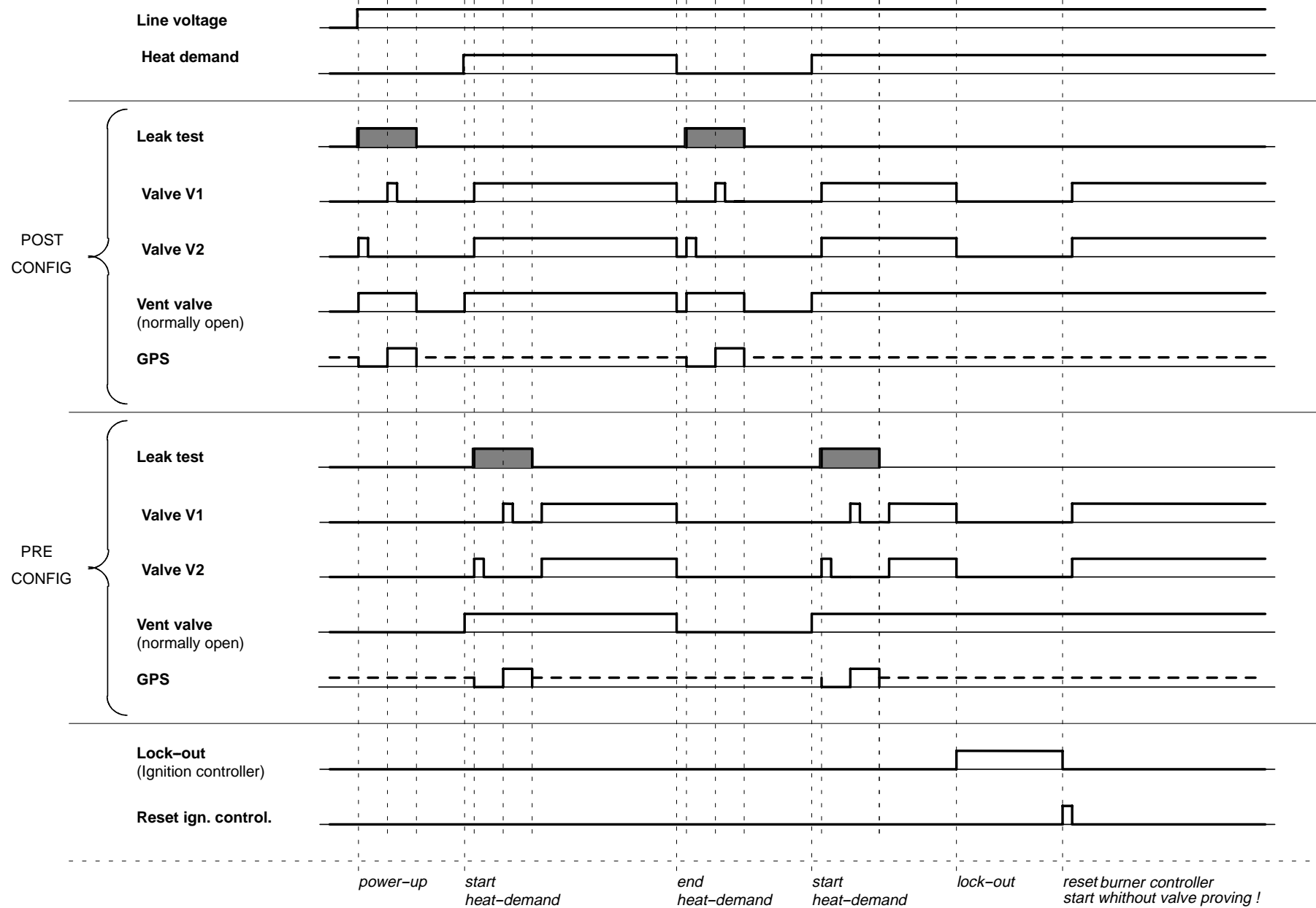

Fig. 5. System sequence with A4021A in post and pre-configuration.

SPECIFICATIONS

Mechanical

Model
A4021A

Dimensions
Refer to Fig. 6.
For mounting bracket dimensions refer to Fig. 7.

Weight
Including subbase: 0.65 Kg

Mounting
ZL030001 subbase.
The subbase can be assembled by 2 screws on a panel. The cover can be removed by loosening one screw. For mounting hole dimensions see Fig. 6. installation drawing.

Orientation
There are no restrictions in the orientation.

Environmental ratings
Ambient temperature range:
Operating : -10 ... 60 °C
Storage : -40 ... 80 °C
Humidity: : 0 – 95% RH at 40 °C (non-condensing)
Vibration : 0.5 G environment

Electrical

Supply voltage
Line voltage: 220 ... 240 Vac, 50 Hz
100 ... 120 Vac, 50 Hz

Refer to Table 2.
Other voltage ranges and frequencies are available on request.

Fusing
The A4021A should be externally fused to prevent damage to the valve proving system, wiring or peripherals
External fuse: 16 A slow max.
Internal fuse: 5 A slow max.

Power consumption
Maximum 4.5 VA

Electrical ratings
Valve outputs: 4A, cos. ϕ 0.7
Vent valve output: 1A, cos. ϕ 0.7
Ignition controller output: 4A, cos. ϕ 0.7
Alarm output: 2A, cos. ϕ 0.7

Electrical connection
4 Wiring conduit according to PG11 are provided in the subbase. M3.5 screw terminals, including earth connection.

Enclosure
IP40

Functional

Field adjustments (calibration)
None

Test-times
Depending on O.S. number.
For A4021A1002 and A4021A1010 per valve: 25 s.

Total test-time (depending on test time per valve)
For model A4021002 and A4021A1010: approx. 65 seconds

Reset
NON-volatile lock-out
Manual, with push-button on controller or with remote reset button.

Design life
> 10 years or 250.000 cycles.

Recommended pressure switch
C6097A2 gas pressure switch

Standards and Approvals (summarized)
The A4021A Series Valve Proving System is conform with the following EC directives:

- Gas Appliance Directive (90/396/EEC)
PIN: CE-0063AS1822
- Low Voltage Directive (73/23/EEC)
- Electro Magnetic Compatibility Directive (89/336/EEC)

Table 2. Connections for A4021A pre- and post-configuration with contact ratings.

Terminal No.	Abbreviations		Direction	Description	Ratings (220 ... 240Vac/100 ... 120Vac, depending on O.S. number)
	pre	post			
1	NO	NO	input	Normally Open contact of the pressure switch (high pressure)	n.a.
2	RESET	RESET	input	Input for external reset connect with momentary switch to line	n.a.
3	LINE	LINE	power-input	Line voltage input for valve proving system.	n.a.
4	N	N	power-input	Neutral input for valve proving system.	n.a.
5	N	N	power	Neutral for external devices.	n.a.
6	N	N	power	Neutral for external devices.	n.a.
7	V1--IN	V2-IN	input	Valve-2 voltage from ignition controller	n.a.
8	V2-OUT	V2-OUT	output	Output connect with Valve-2	4A
9	HD	LGPS	input	Heat-demand input (pre-configuration) or LGPS input (post-configuration)	n.a.
10	ALARM	ALARM	input	Alarm input	n.a.
11	ALARM	ALARM	output	Alarm output	2A
12	RB	RB	input	Read back signal for: heat-demand (post- config.) ign. contr. (pre-config.)	n.a.
13	VENT	VENT	output	Normally open valve output	1A
14	IGNCTR	HD	output	Heat call signal to ignition controller, when there is a heat call and the valve proving has taken place	4A
15	V2--IN	V1-IN	input	Valve-1 voltage from ignition controller	n.a.
16	V1-OUT	V1-OUT	output	Output connect with Valve-1	4A

NOTE: $\cos. \varphi = 0.7$ for all outputs

DIMENSIONAL DRAWINGS

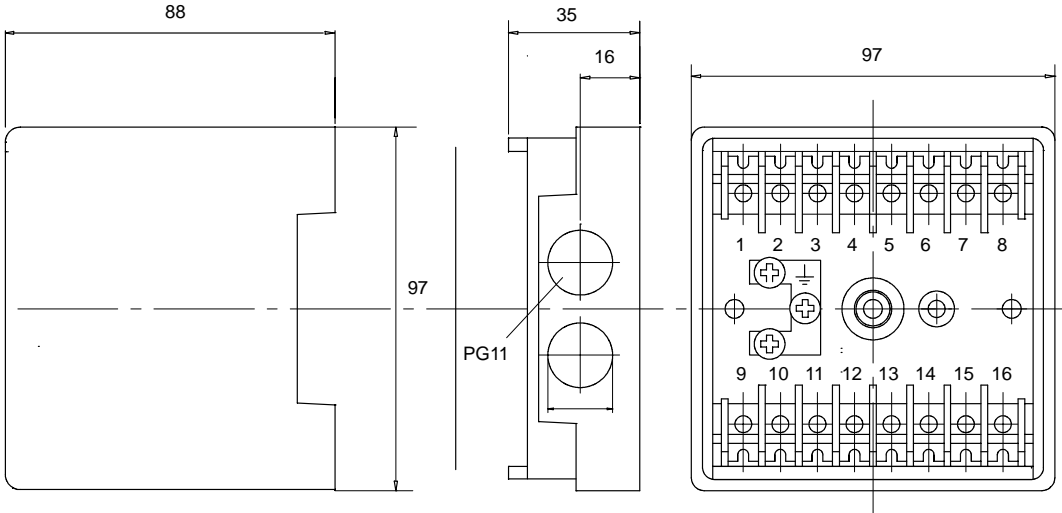

Fig. 6. Mounting dimensions of A4021A and subbase in millimeters

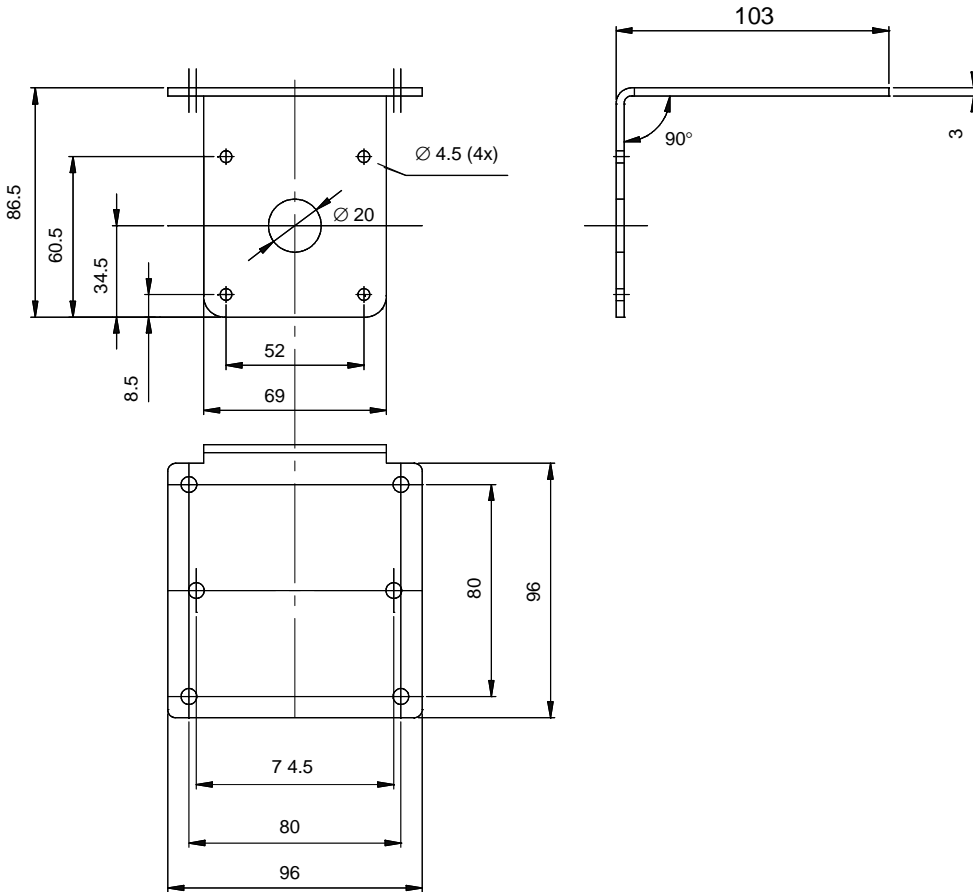

Fig. 7. Mounting bracket A4021A for VQ400 and VE5000 Series in millimeters

INSTALLATION AND WIRING

Installation

IMPORTANT

Read these instructions carefully. Failure to follow the instructions could damage the product or cause a hazardous condition.

1. Before installing or replacing any control check that the test time is correct for the application. Never use a type with a smaller test time than the calculated test time for the application.

Check the ratings given in the instructions and on the product to make sure the product is suitable for your application.

2. The installation has to be carried out by qualified personnel only.
3. Carry out a thorough checkout when installation is completed.

Mounting wiring subbase

NOTE: For installation dimensions, see Fig. 6.

1. The subbase can be mounted in any position. Make sure that the LEDs indicating the test sequence and faults-causes are clearly visible.
2. Select a location within an electrical panel. Be sure to allow adequate clearance for servicing, installation and electrical field connections.
3. For surface mounting, use the back of the subbase as a template to mark the two screw locations. Drill the pilot holes.
4. Securely mount the subbase using two M3.5 x 0.6 screws.

Wiring

CAUTION

1. Disconnect power supply before beginning the installation to prevent electrical shock, equipment and control damage. More than one power supply disconnect may be involved.
2. Wiring connections for the A4021A are unique, therefore, refer to Table 2. and Fig. 6. for proper subbase wiring.
3. The A4021A must be installed with fixed wiring for phase and neutral connections.
4. Wiring must comply with all applicable codes, ordinances and regulations.
5. After moving the A4021A valve proving system from outdoor to indoor conditions, condensation may occur. Do not connect condensed valve proving system to mains.
6. The A4021A is not suitable for phase-phase mains., can only be used with phase - neutral mains.
7. For each application diagram, local approval may be needed

General considerations

There are two basic wiring diagrams:

- valve proving before burner start-up: pre-configuration.
- valve proving at end of heat demand: post-configuration.

Wiring

1. For proper subbase wiring, refer to Table 2.
2. Disconnect the power supply from the main disconnect before beginning the installation to prevent electrical shock and equipment damage. More than one disconnect may be involved.
3. All wiring must comply with all applicable electrical codes, ordinances and regulations.
4. Use the COM and NO contacts on both pressure switches (LGPS and GPS).
5. Make sure loads do not exceed the terminal ratings. refer to the label on the valve proving system, or to the ratings in the Specifications, see Table 2.
6. Check the power supply circuit. the voltage and frequency tolerance must match those of the valve proving system. Add the required disconnect means and overload protection.
7. Check all wiring circuits before installing the valve proving system on the subbase
8. Install all electrical connectors.
9. Restore power to the panel.

Pressure switch

The pressure switch can be a normal normally open gas pressure switch which is suitable for the appropriate pressure levels and a voltage of 220 ... 240 Vac. Refer to the enclosed instructions of the pressure switch. The switching point of the GPS must be at 50 % of the nominal line-pressure. Recommended gas pressure switch: C6097A2

GENERAL WIRING DIAGRAMS

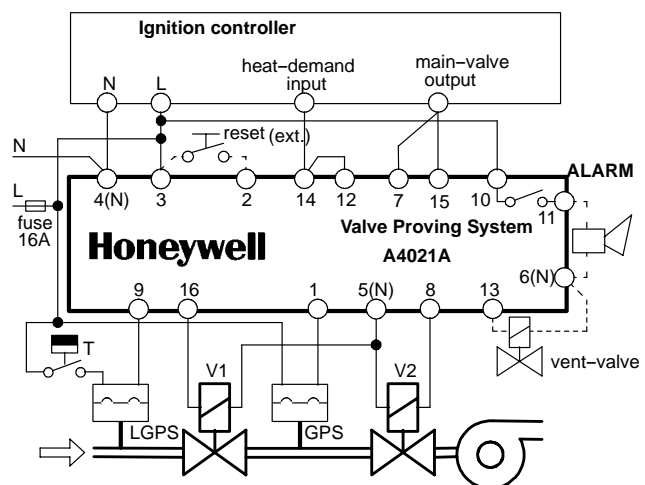

Fig. 8. Wiring diagram for 2-valve configuration pre-configuration

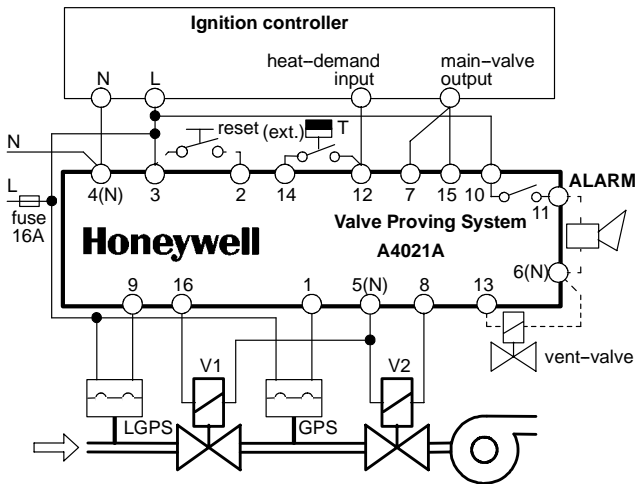

Fig. 9. Wiring diagram 2-valve configuration for post-configuration

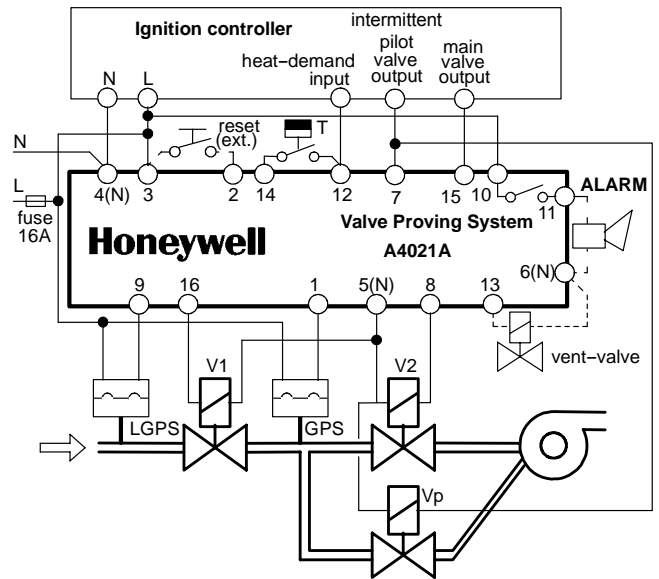

Fig. 11. Wiring diagram 3-valve configuration (post-configuration)

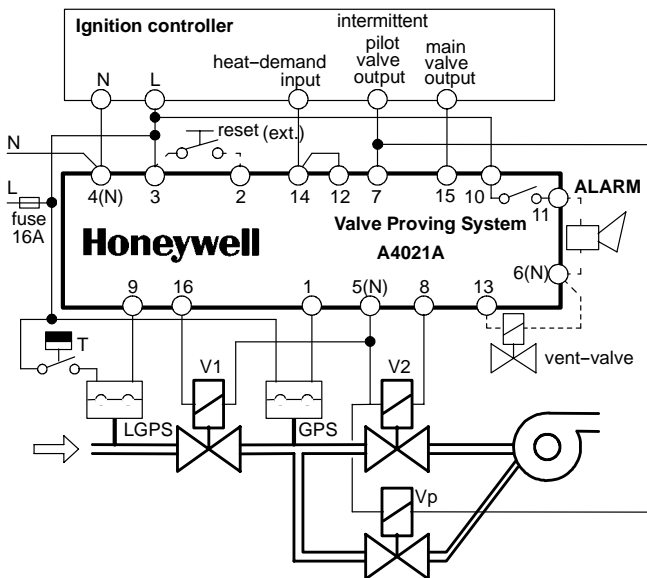

Fig. 10. wiring diagram 3-valve configuration (pre-configuration)

WARNING

These are general wiring diagrams and have not been submitted for approval by an official approval body. Depending on the application and used ignition controller special wiring diagrams may be required.

OPERATION

Sequence of operation

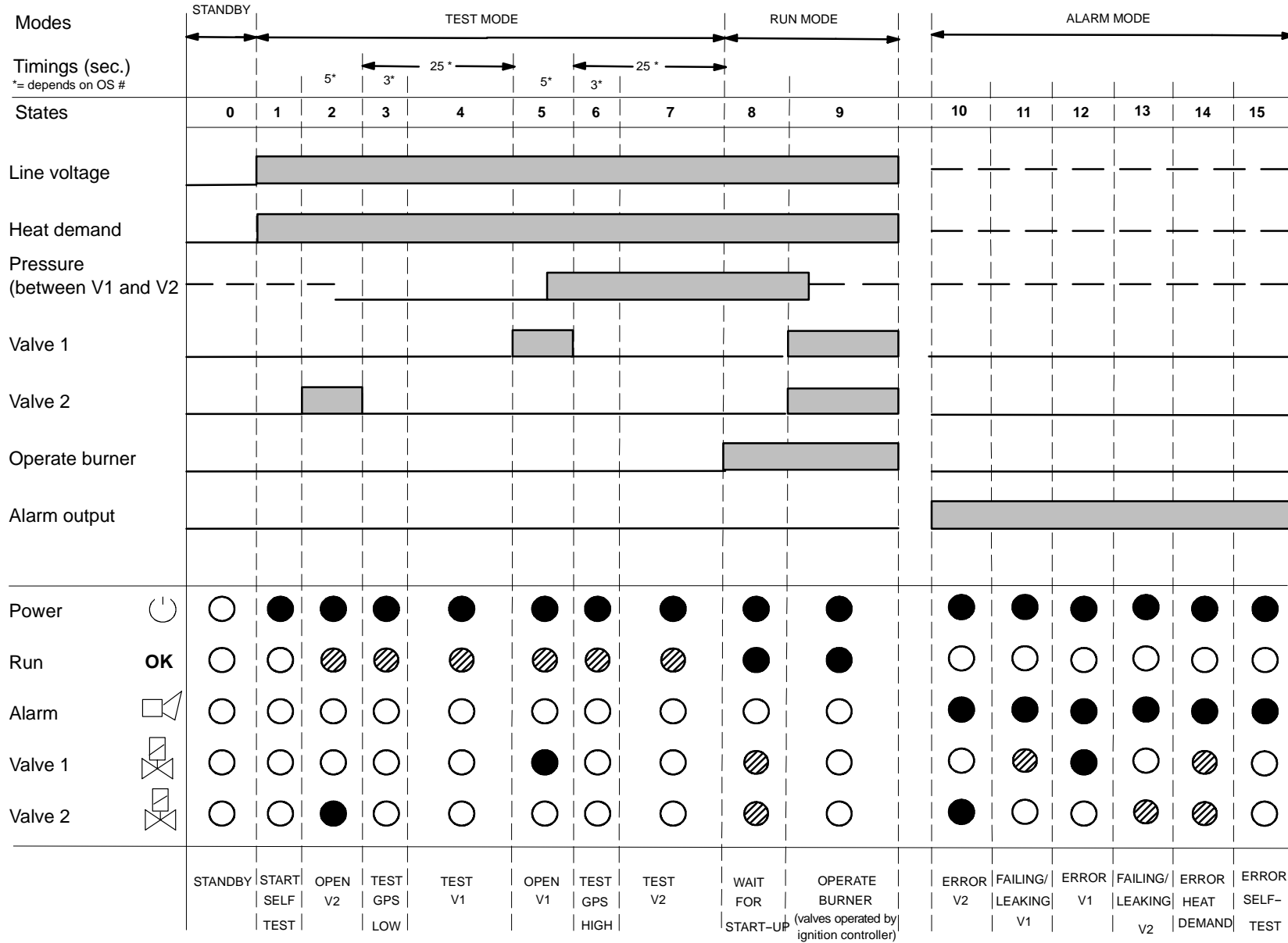

⚠ WARNING

No standard valve proving after lock-out of the ignition controller

○ = LED is off ◐ = blinking LED ● = LED on

CHECKOUT

The procedures described in this chapter are related to A4021A. For adjustments on the other additional functionalities (e.g. pressure switch), refer to the included instruction sheet of the product in question in the package.



WARNING

Phase - neutral dependency

As the EARTH is not connected to the actual A4021A (earth only connected to the sub-base), it is not possible to detect whether the line and neutral are correct connected on the A4021A.

Exchanged connection of the phase and neutral can lead to hazardous situations, when a short-circuit in one of the valve connections occurs. Therefore the A4021A can only be used with fixed wiring for the line-voltage connections. Make sure that phase and neutral are connected as instructed in the Wiring section.

Final checkout of the installation

Set the appliance in operation after any adjustment and observe several complete cycles to ensure that all burner components function correctly.

Make sure that phase and neutral are connected as instructed in the Wiring section.

TROUBLESHOOTING

CAUTION

1. Use utmost care while troubleshooting the A4021A, line voltage is present on some of the terminals when power is on.
2. Line voltage is present on the terminals when the cover is removed. Make sure that the main power supply is switched off before removing the cover.
3. The A4021A contains no serviceable parts. Any attempt or replacement of parts (except from internal fuse) will affect the safety of this device and is therefor not allowed.

General

If you encounter a error or fail on V1 or V2, refer to the instruction sheet of the valve.































If you encounter other problems in the system, refer to the Troubleshooting section in the instruction sheet for the appropriate flame safeguard control.



Upon completion of troubleshooting, be sure to perform the Checkout procedures previously specified for the A4021A.

NOTE: Instructions for replacing the cover and fuse are given in the Service section.

Before making a replacement, make sure you have the correct part (check its part number and voltage rating)

Table 3. Troubleshooting A4021A

States	PWR	RUN	ALARM	V1	V2	Alarm mode	Cause	Action
10						Error V2	V2 is damaged or V2 is wrong/not connected	Check connections V2 and if necessary replace V2
11						Failing/leaking V1	Allowed leak-rate (V1) higher than 0.1% of the maximum flow-rate	Check the gas pressure switch (GPS) and if needed replace V1
12						Error V1	V1 is damaged or V1 is wrong/not connected	Check connections V1 and if necessary replace V1
13						Failing/leaking V2	Allowed leak-rate (V2) higher than 0.1% of the maximum flow-rate	Check gas pressure switch (GPS) and if needed replace V2
14						Error heat demand	Heat demand read-back error .	Check if pin 12 on A4021A is connected
15						Error self-test	Internal Hardware/Software error	Reset main supply, reset A4021A; if error still occurs: replace A4021A

 = LED is off	 = blinking LED	 = LED on
---	--	--

Honeywell

Honeywell Industrial Combustion

Luchthavenlaan 16
1800 Vilvoorde
belgium
Phone: +32 2 255 09 09

<http://hic.emea.honeywell.com>